

SSAB

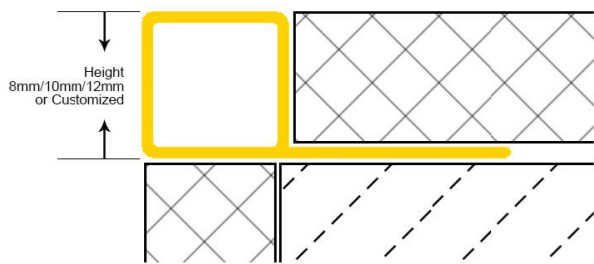

Size Details Specification Can be Customized



SSAG



Size Details Specification Can be Customized

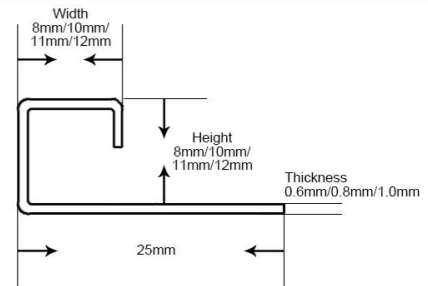

SSAG8



Size Details Specification Can be Customized

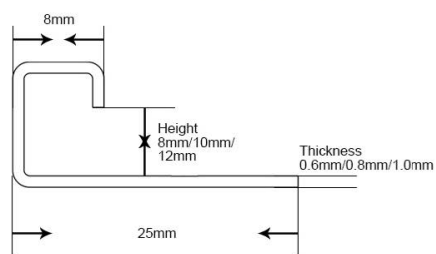

SSAGS



Size Details Specification Can be Customized

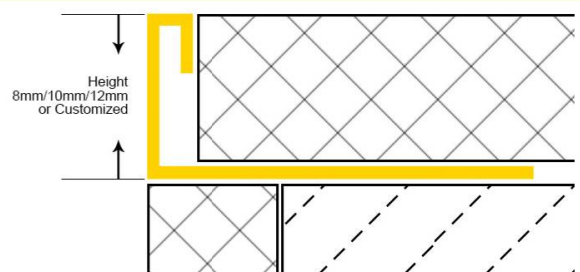

SSAL



Size Details Specification Can be Customized

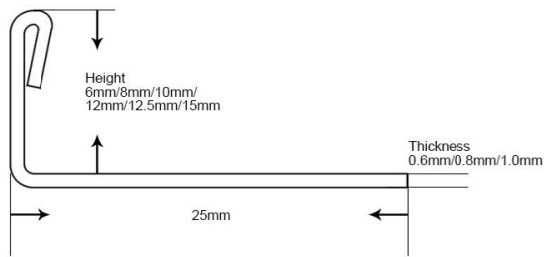

SSAQ



Size Details Specification Can be Customized

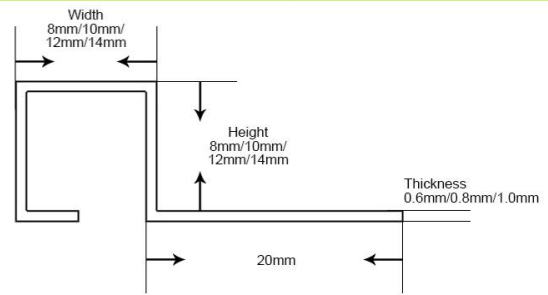

SSAS



Size Details Specification Can be Customized

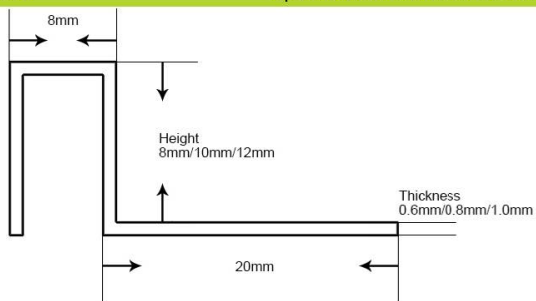

SSASS



Size Details Specification Can be Customized

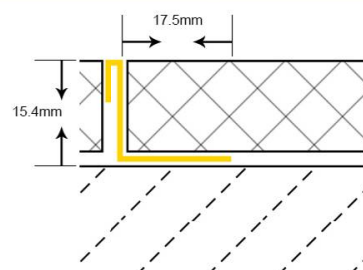

SSCR



Size Details Specification Can be Customized

SSCR1



Size Details Specification Can be Customized

SSCX

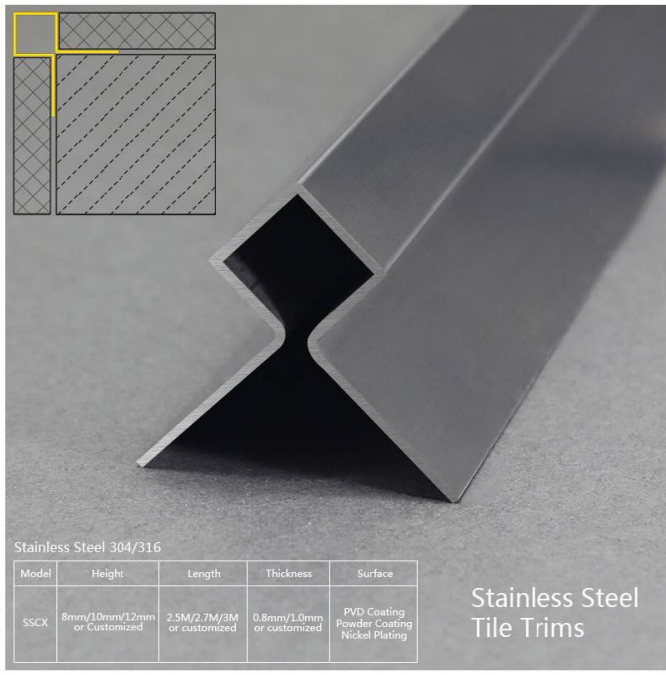

Size Details Specification Can be Customized

SSFG

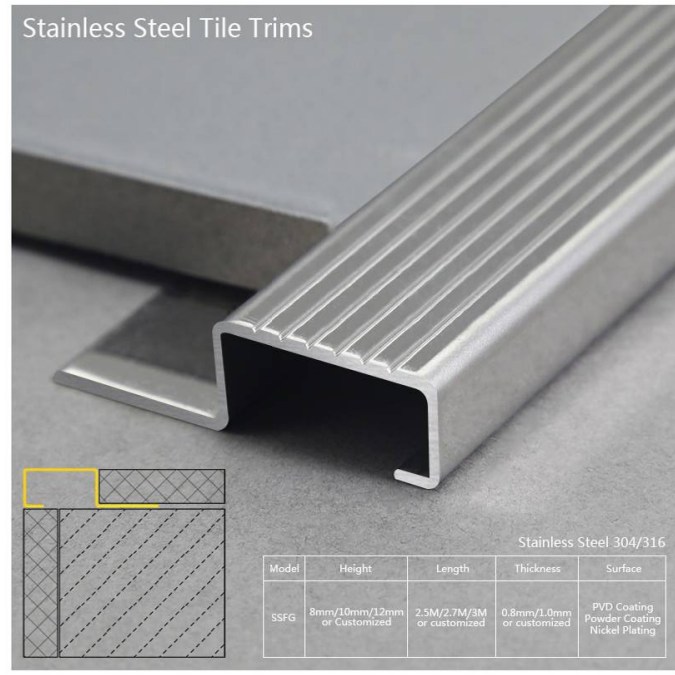

Size Details Specification Can be Customized

Stainless Steel 304/316

Model	Height	Length	Thickness	Surface
SSCR	8mm/10mm/12mm or Customized	2.5M/2.7M/3M or customized	0.8mm/1.0mm or customized	PVD Coating Powder Coating Nickel Plating

Stainless Steel 304/316

Model	Height	Length	Thickness	Surface
SSCR1	8mm/10mm/12mm or Customized	2.5M/2.7M/3M or customized	0.8mm/1.0mm or customized	PVD Coating Powder Coating Nickel Plating

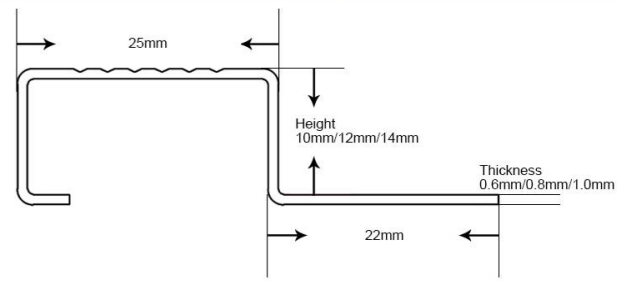
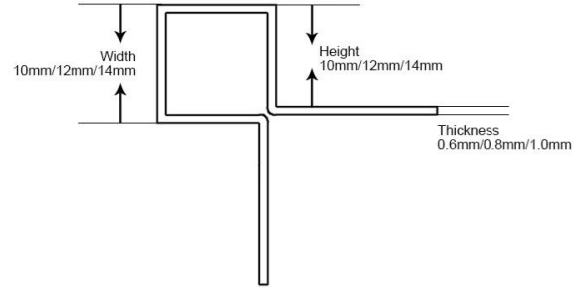
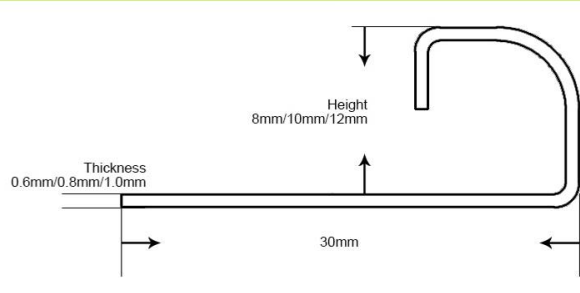
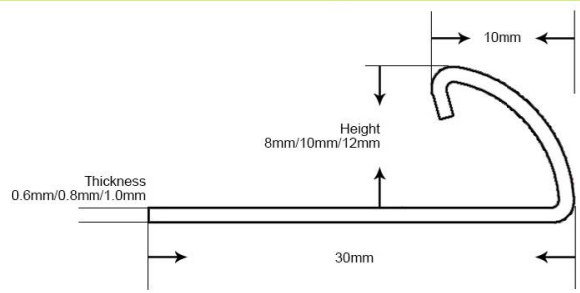

Stainless Steel 304/316

Model	Height	Length	Thickness	Surface
SSCX	8mm/10mm/12mm or Customized	2.5M/2.7M/3M or customized	0.8mm/1.0mm or customized	PVD Coating Powder Coating Nickel Plating

Stainless Steel 304/316

Model	Height	Length	Thickness	Surface
SSFG	8mm/10mm/12mm or Customized	2.5M/2.7M/3M or customized	0.8mm/1.0mm or customized	PVD Coating Powder Coating Nickel Plating

SSFG2

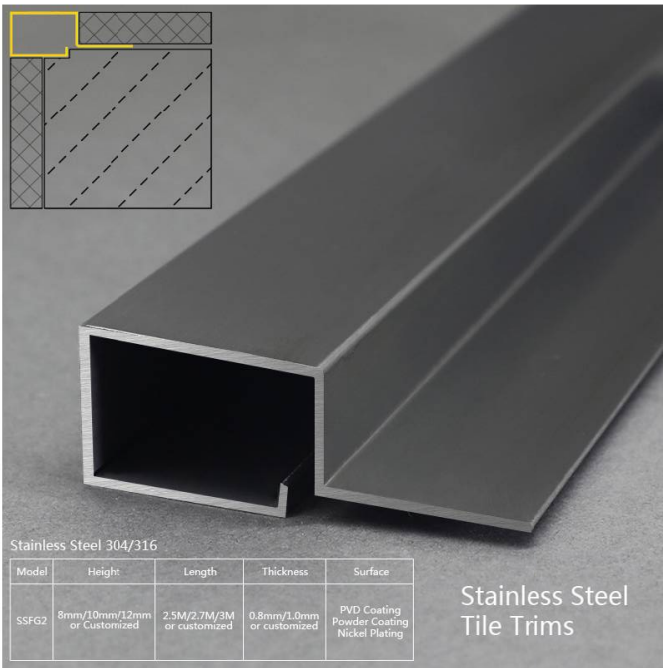

Stainless Steel 304/316

Model	Height	Length	Thickness	Surface
SSFG2	8mm/10mm/12mm or Customized	2.5M/2.7M/3M or customized	0.8mm/1.0mm or customized	PVD Coating Powder Coating Nickel Plating

Stainless Steel Tile Trims

Size Details Specification Can be Customized

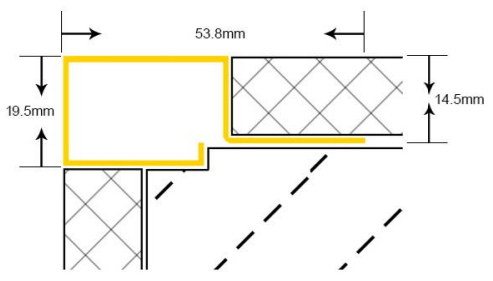

SSLX

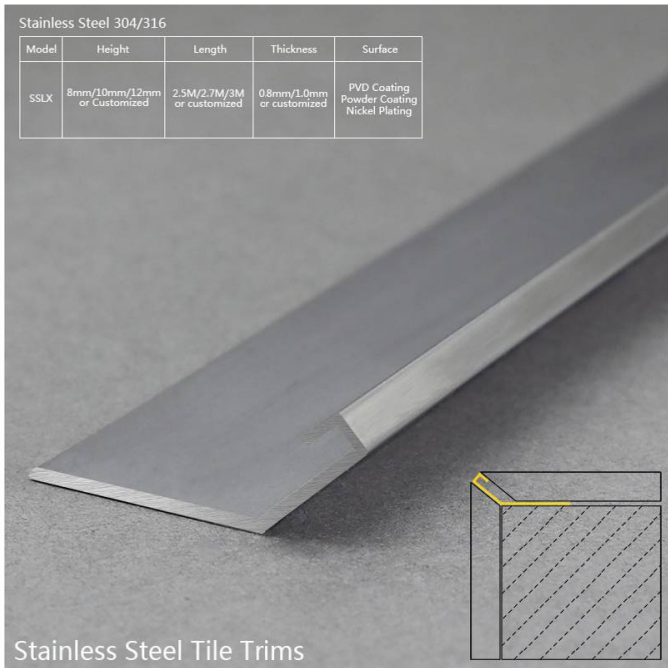

Stainless Steel 304/316

Model	Height	Length	Thickness	Surface
SSLX	8mm/10mm/12mm or Customized	2.5M/2.7M/3M or customized	0.8mm/1.0mm or customized	PVD Coating Powder Coating Nickel Plating

Stainless Steel Tile Trims

Size Details Specification Can be Customized

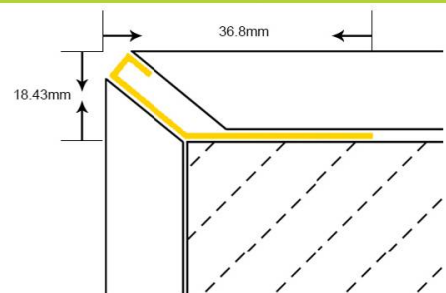

SSRX



Stainless Steel 304/316

Model	Height	Length	Thickness	Surface
SSRX	8mm/10mm/12mm or Customized	2.5M/2.7M/3M or customized	0.8mm/1.0mm or customized	PVD Coating Powder Coating Nickel Plating

Stainless Steel Tile Trims

Size Details Specification Can be Customized

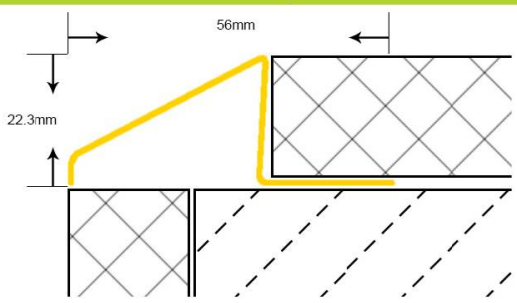

SSTB



Stainless Steel 304/316

Model	Height	Length	Thickness	Surface
SSTB	8mm/10mm/12mm or Customized	2.5M/2.7M/3M or customized	0.8mm/1.0mm or customized	PVD Coating Powder Coating Nickel Plating

Stainless Steel Tile Trims

Size Details Specification Can be Customized

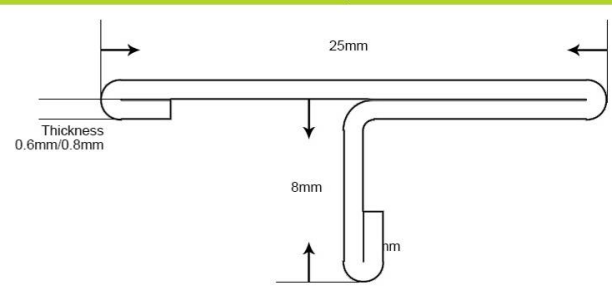

SSTR

Stainless Steel Tile Trims

Stainless Steel 304/316

Model	Height	Length	Thickness	Surface
SSTR	8mm/10mm/12mm or Customized	2.5M/2.7M/3M or customized	0.8mm/1.0mm or customized	PVD Coating Powder Coating Nickel Plating

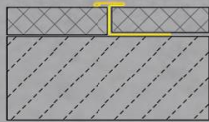

Size Details

Specification Can be Customized

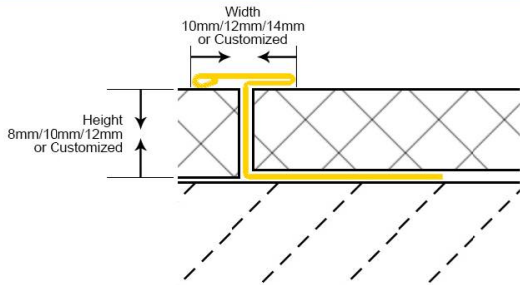

SSTS

Stainless Steel 304/316

Model	Height	Length	Thickness	Surface
SSTS	8mm/10mm/12mm or Customized	2.5M/2.7M/3M or customized	0.8mm/1.0mm or customized	PVD Coating Powder Coating Nickel Plating

Stainless Steel Tile Trims

Size Details

Specification Can be Customized

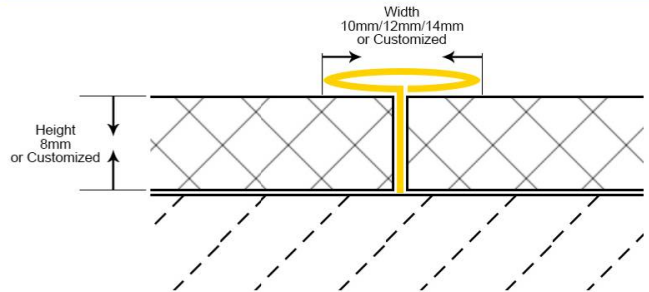

SSTS1

Stainless Steel Tile Trims

Stainless Steel 304/316

Model	Height	Length	Thickness	Surface
SSTS1	8mm/10mm/12mm or Customized	2.5M/2.7M/3M or customized	0.8mm/1.0mm or customized	PVD Coating Powder Coating Nickel Plating



Size Details

Specification Can be Customized

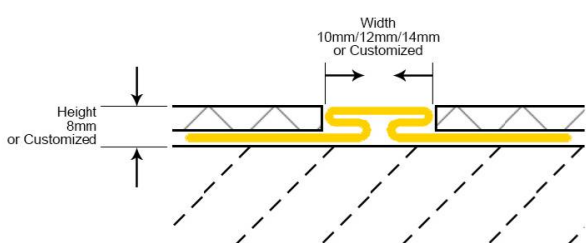

SSUB

Stainless Steel 304/316

Model	Height	Length	Thickness	Surface
SSUB	8mm/10mm/12mm or Customized	2.5M/2.7M/3M or customized	0.8mm/1.0mm or customized	PVD Coating Powder Coating Nickel Plating

Stainless Steel Tile Trims

Size Details

Specification Can be Customized

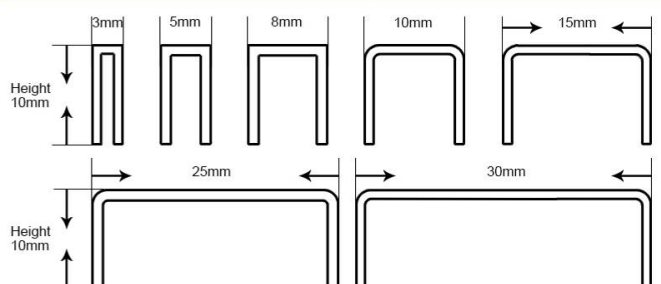

SSUM

Stainless Steel 304/316

Model	Height	Length	Thickness	Surface
SSUM	8mm/10mm/12mm or Customized	2.5M/2.7M/3M or customized	0.8mm/1.0mm or customized	PVD Coating Powder Coating Nickel Plating

Stainless Steel Tile Trims

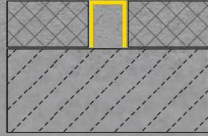

SSUS

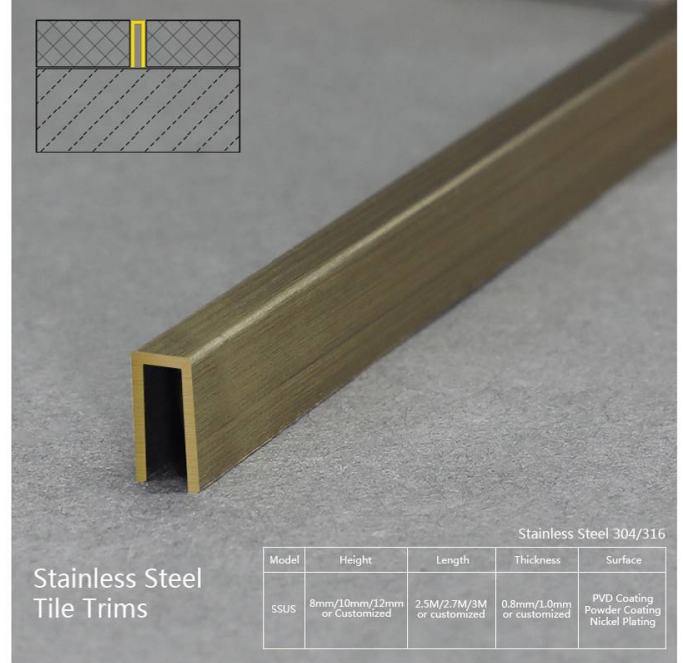

Stainless Steel Tile Trims

Stainless Steel 304/316

Model	Height	Length	Thickness	Surface
SSUS	8mm/10mm/12mm or Customized	2.5M/2.7M/3M or customized	0.8mm/1.0mm or customized	PVD Coating Powder Coating Nickel Plating

Size Details

Specification Can be Customized

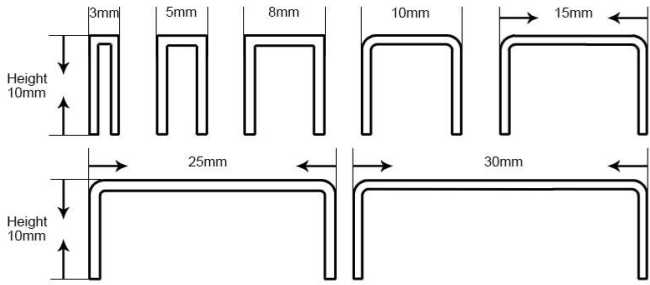

Size Details

Specification Can be Customized

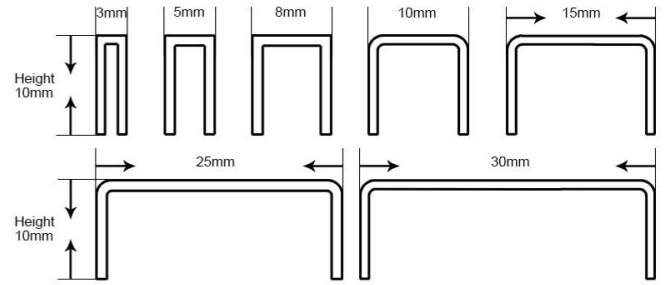

Foshan Shi Hua Aluminium Co., Ltd.

www.shihua-aluminium.com